

Year 6 PROMPT sheet

6/1 Place value in numbers to 10million

The position of the digit gives its size

Ten millions	Millions	Hundred thousands	Ten thousands	thousands	hundreds	tens	ones
1	2	3	4	5	6	7	8

Example

The value of the digit '1' is 10 000 000

The value of the digit '2' is 2 000 000

The value of the digit '3' is 300 000

The value of the digit '4' is 40 000

6/1 Round whole numbers

Example 1 - Round 342 679 to the nearest 10 000

- Step 1 - Find the 'round-off digit' - 4
- Step 2 - Move one digit to the right - 2

4 or less? YES - leave 'round off digit' unchanged
- Replace following digits with zeros

ANSWER - 340 000

Example 2 - Round 345 679 to the nearest 10 000

- Step 1 - Find the 'round-off digit' - 4
- Step 2 - Move one digit to the right - 5

5 or more? YES - add one to 'round off digit'
- Replace following digits with zeros

ANSWER - 350 000

6/2 Negative numbers

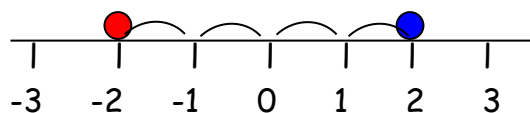

$2 > -2$ → We say 2 is bigger than -2

$-2 < 2$ → We say -2 is less than 2

The difference between 2 and $-2 = 4$ (see line)

Remember the rules:

- When subtracting go down the number line
- When adding go up the number line
- $8 + -2$ is the same as $8 - 2 = 6$
- $8 - +2$ is the same as $8 - 2 = 6$
- $8 - -2$ is the same as $8 + 2 = 10$

6/3 Multiply numbers & estimate to check

e.g. 152×34

COLUMN METHOD

$$\begin{array}{r} 152 \\ 34x \\ \hline 608 \quad (x4) \\ 4560 \quad (x30) \\ \hline 5168 \end{array}$$

6/3 Use estimates to check calculations

$$\begin{array}{l} 152 \times 34 \\ \approx 150 \times 30 \\ \approx 4500 \end{array}$$

\approx is the symbol for 'approximately'

6/3 Divide numbers & estimate to check

With a remainder also expressed as a fraction

e.g. $4928 \div 32$

Drop Down Method

$$\begin{array}{r} 028 \\ 15 \overline{) 432} \\ \underline{-30} \\ 132 \\ \underline{-120} \\ 12 \end{array}$$

ANSWER - $432 \div 15 = 28 \text{ r } 12$

$$= 28 \frac{12}{15}$$

6/3 continued

With a remainder expressed as a decimal

$$\begin{array}{r}
 028.8 \\
 15 \overline{)432.0} \\
 \underline{-30} \\
 132 \\
 \underline{-120} \\
 12
 \end{array}$$

ANSWER - $432 \div 15 = 28.8$

6/3 Use estimates to check calculations

$432 \div 15$
 $\approx 450 \div 15$
 ≈ 30

6/4 Factors, multiples & primes

- FACTORS** are what divides exactly into a number

e.g. Factors of 12 are: Factors of 18 are:

1	12
2	6
3	4

1	18
2	9
3	6

The common factors of 12 & 18 are: 1, 2, 3, 6,
The Highest Common Factor is: 6

- PRIME NUMBERS** (See Year 5)

e.g. Factors of 7 are: Factors of 13 are

1	7
---	---

1	13
---	----

So 7 and 13 are both prime numbers

- MULTIPLES** are the times table answers

e.g. Multiples of 5 are:

5	10	15	20	25
---	----	----	----	----	-------

Multiples of 4 are:

4	8	12	16	20
---	---	----	----	----	-------

The Lowest Common Multiple of 5 and 4 is: 20

6/5 Order of operations

Bracket

Indices

Divide

Multiply

Add

Subtract

} Do these in the order they appear

} Do these in the order they appear

e.g. $3 + 4 \times 6 - 5 = 22$



first
 $(2 + 1) \times 3 = 9$
 ↑
 first

6/6 Addition

- Line up the digits in the correct columns

e.g. $48p + \pounds 2.84 + \pounds 9$

$$\begin{array}{r}
 0.48 \\
 2.84 \\
 +9.00 \\
 \hline
 \pounds 12.32 \\
 1 \quad 1 \quad 1
 \end{array}$$

6/6 Subtraction

- Line up the digits in the correct columns

e.g. $645 - 427$

H T O
6 ³ 4 ¹⁵
- 4 2 7

2 1 8

6/7 Equivalent fractions

- To simplify a fraction

Example: $\frac{27}{36}$

First find the highest common factor of the numerator and denominator - which is 9, then divide

$$\frac{27 \div 9}{36 \div 9} = \frac{3}{4}$$

- To change fractions to the same denominator

Example: $\frac{3}{4}$ and $\frac{2}{3}$

Find the highest common multiple of the denominators - which is 12, then multiply:

$$\frac{3 \times 3}{4 \times 3} = \frac{9}{12} \quad \text{and} \quad \frac{2 \times 4}{3 \times 4} = \frac{8}{12}$$

6/8 Add & subtract fractions

- Make the denominators the same

$\begin{aligned} \text{e.g. } & \frac{1}{5} + \frac{7}{10} \\ &= \frac{2}{10} + \frac{7}{10} \\ &= \frac{9}{10} \end{aligned}$	$\begin{aligned} \text{e.g. } & \frac{4}{5} - \frac{2}{3} \\ &= \frac{12}{15} - \frac{10}{15} \\ &= \frac{2}{15} \end{aligned}$
--	---

Do not add denominators

e.g. $35.6 \times 10 = 356$

Hundreds	Tens	Ones	•	tenths
	3	5	•	6
3	5	6	•	

- To **divide by 10**, move each digit one place to the right

e.g. $35.6 \div 10 = 3.56$

Tens	Ones	•	tenths	hundredths
3	5	•	6	
	3	•	5	6

- To **multiply by 100**, move each digit 2 places to the left
- To **divide by 100**, move each digit 2 places to the right

6/9 Multiply fractions

- Write 5 as $\frac{5}{1}$
- Multiply numerators & denominators

$\begin{aligned} \text{e.g. } & 5 \times \frac{2}{3} \\ &= \frac{5}{1} \times \frac{2}{3} \\ &= \frac{10}{3} = 3\frac{1}{3} \end{aligned}$	$\begin{aligned} \text{e.g. } & \frac{4}{5} \times \frac{2}{3} \\ &= \frac{8}{15} \end{aligned}$
--	--

6/9 Divide fractions

- Write 5 as $\frac{5}{1}$
- Invert the fraction after \div sign
- Multiply numerators & denominators

$\begin{aligned} \text{e.g. } & \frac{2}{3} \div 5 \\ &= \frac{2}{3} \times \frac{1}{5} \\ &= \frac{2}{15} \end{aligned}$	$\begin{aligned} \text{e.g. } & \frac{4}{5} \div \frac{2}{3} \\ &= \frac{4}{5} \times \frac{3}{2} \\ &= \frac{12}{10} = 1\frac{2}{10} = 1\frac{1}{5} \end{aligned}$
---	---

6/10 Multiply/divide decimals by 10, 100

thousands	hundreds	tens	ones	•	tenths	hundredths	thousandths
4	3	5	2	•	6	1	7

- To **multiply by 10**, move each digit one place to the left

AN ALTERNATE METHOD

Instead of moving the digits
Move the decimal point the opposite way

6/11 Multiply decimals

- Step 1 - remove the decimal point
- Step 2 - multiply the two numbers
- Step 3 - Put the decimal back in

Example: 0.06×8

=> 6×8

=> 48

=> 0.48

6/11 Divide decimals

- Use the bus shelter method
- Keep the decimal point in the same place
- Add zeros for remainders

Example: $6.28 \div 5$

$$\begin{array}{r} 1.256 \\ 5 \overline{) 6.280} \end{array}$$

6/12 Fraction, decimal, percentage equivalents

LEARN THESE:

$$\frac{1}{4} = 0.25 = 25\%$$

$$\frac{1}{2} = 0.5 = 50\%$$

$$\frac{3}{4} = 0.75 = 75\%$$

$$\frac{1}{10} = 0.1 = 10\%$$

• **Percentage to decimal to fraction**

$$27\% = 0.27 = \frac{27}{100}$$

$$7\% = 0.07 = \frac{7}{100}$$

$$70\% = 0.7 = \frac{70}{100} = \frac{7}{10}$$

• **Decimal to percentage to fraction**

$$0.3 = 30\% = \frac{3}{10}$$

$$0.03 = 3\% = \frac{3}{100}$$

$$0.39 = 39\% = \frac{39}{100}$$

• **Fraction to decimal to percentage**

$$\frac{4}{5} = \frac{80}{100} = 80\% = 0.8$$



Change to 100

$$\frac{3}{8} = 3 \div 8 = 8 \overline{) 3.06040} = 0.375 = 37.5\%$$

$$\frac{9}{12} = \frac{3}{4} = 0.75 = 75\%$$

Cancel by 3

6/13 Fraction of quantity

- **4 means $\div 5 \times 4$**

5

e.g. To find $\frac{4}{5}$ of £40

5

$$£40 \div 5 \times 4 = £40$$

6/13 Percentage of quantity

Use only

- 50% - $\frac{1}{2}$
- 10% - $\frac{1}{10}$
- 1% - $\frac{1}{100}$

Example : To find 35% of £400

$$10\% = £40$$

$$20\% = £80$$

$$5\% = £20$$

$$35\% = £140$$

6/14 Similar shapes

When a shape is enlarged by a scale factor the two shapes are called **SIMILAR** shapes

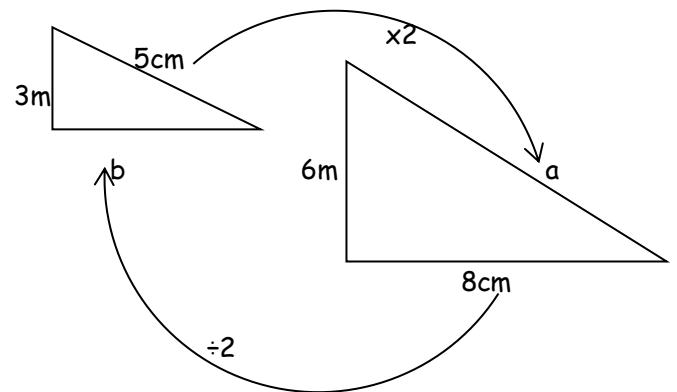

$$\text{Scale factor} = 6 \div 3 = 2$$

$$\text{Length } a = 5 \times 2 = 10\text{cm}$$

$$\text{Length } b = 8 \div 2 = 4\text{cm}$$

6/14 Unequal sharing

Example- unequal sharing of sweets

A gets

B gets

3 shares

4 shares

$$\Rightarrow 3 \text{ sweets} \rightarrow \times 4$$

$$4 \text{ sweets} \rightarrow \times 4$$

$$\Rightarrow 12 \text{ sweets}$$

$$16 \text{ sweets}$$

6/15 Express missing numbers algebraically

An unknown number is given a letter

Examples

$2a - 4 = 8$

$2a = 12$ so $a = 6$

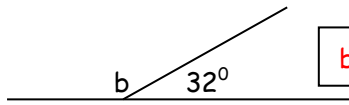

$b + 32 = 180$ so $b = 148^\circ$

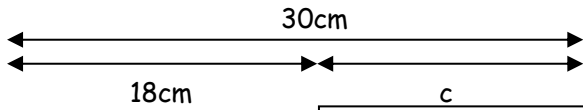

$18 + c = 30$ so $c = 12$

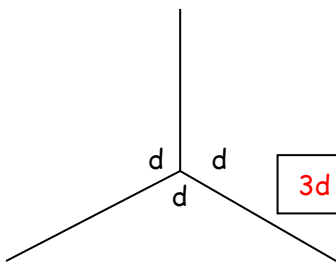

$3d = 360^\circ$ so $d = 120^\circ$

6/15 Use a word formula

Example: - Time to cook a turkey
Cook for 45min per kg weight
Then a further 45min

For a 6kg turkey, follow the formula:
 $45\text{min} \times 6 + 45\text{min}$
 $= 270\text{min} + 45\text{min}$
 $= 315\text{min}$
 $= \underline{5\text{h } 15\text{min}}$

6/16 Number sequences

- Understand position and term

Position	1	2	3	4
Term	3	7	11	15

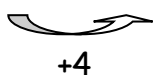

Term to term rule = **+4**
Position to term rule is $x \times 4 - 1$
(because position $1 \times 4 - 1 = 3$)
 $n\text{th term} = n \times 4 - 1 = 4n - 1$

- Generate terms of a sequence

If the nth term is $5n + 1$

1st term ($n=1$) = $5 \times 1 + 1 = 6$

2nd term ($n=2$) = $5 \times 2 + 1 = 11$

3rd term ($n=3$) = $5 \times 3 + 1 = 16$

6/17 Possible solutions of a number sentence

Example: x and y are numbers

Rule: $x + y = 5$

Possible solutions: $x = 0$ and $y = 5$

$x = 1$ and $y = 4$

$x = 2$ and $y = 3$

$x = 3$ and $y = 2$

$x = 4$ and $y = 1$

$x = 5$ and $y = 0$

6/18 Convert units of measure METRIC

When converting measurements follow these rules:

- When converting from a **larger unit to a smaller** unit we **multiply** (\times)
- When converting from a **smaller unit to a larger** unit we **divide** (\div)

UNITS of LENGTH

$10\text{mm} = 1\text{cm}$

$100\text{cm} = 1\text{m}$

$1000\text{m} = 1\text{km}$

UNITS of MASS

$1000\text{g} = 1\text{kg}$

$1000\text{kg} = 1\text{tonne}$

UNITS of TIME

$60\text{sec} = 1\text{min}$

$60\text{min} = 1\text{hour}$

$24\text{h} = 1\text{day}$

$365\text{days} = 1\text{year}$

UNITS of VOLUME

$1000\text{ml} = 1\text{litre}$

$100\text{cl} = 1\text{litre}$

6/19 Convert units of measure METRIC/IMPERIAL

LEARN: 5 miles = 8km

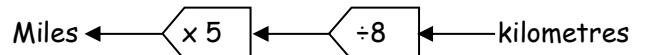
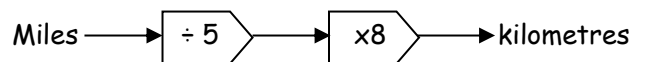

6/20 Perimeter and area of shapes

Shapes can have the SAME area but different perimeters

The area of each shape is 9 squares

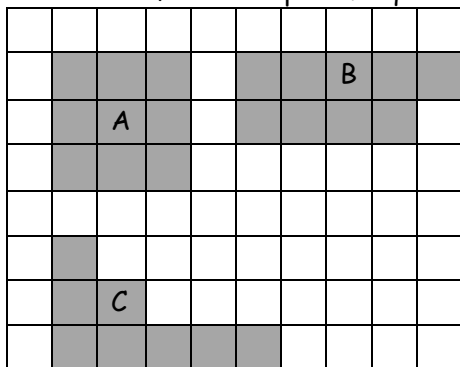

Perimeter of each shape is different
A - 12; B - 14; C - 16

Example : Triangle with side and angles given

- Draw line AB = 7cm
- Draw angle 34° at point A from line AB
- Draw angle 47° at point B from line AB
- Extend to intersect the lines at C

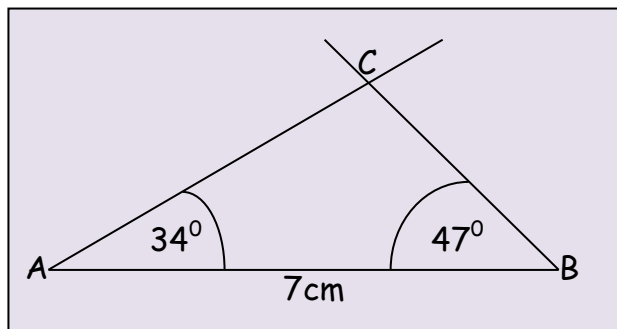

6/21 Area of parallelogram & triangle

- **Area of parallelogram**

$$\begin{aligned} \text{Area of parallelogram} &= b \times h \\ &= 8 \times 5 \\ &= \underline{40\text{cm}^2} \end{aligned}$$

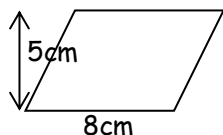

- **Area of triangle ($\frac{1}{2}$ a parallelogram)**

$$\begin{aligned} \text{Area of triangle} &= \frac{b \times h}{2} \\ &= \frac{8 \times 5}{2} \\ &= \underline{20\text{cm}^2} \end{aligned}$$

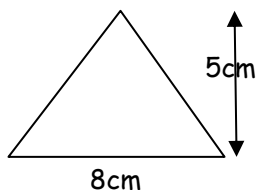

6/22 Volume

- **Volume of cuboid**

$$\begin{aligned} \text{Volume} &= l \times w \times h \\ &= 5 \times 3 \times 2 \\ &= \underline{30\text{cm}^3} \end{aligned}$$

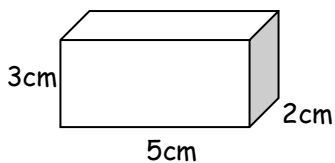

- **Volume of cube**

$$\begin{aligned} \text{Volume} &= l \times w \times h \\ &= 3 \times 3 \times 3 \\ &= \underline{27\text{m}^3} \end{aligned}$$

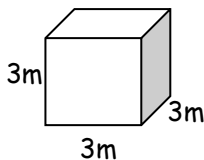

6/23 Construct 3D shapes

CUBE & its net

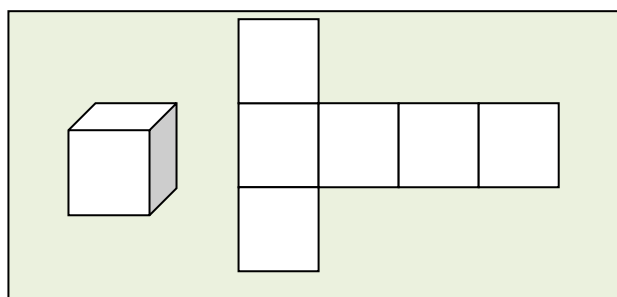

CUBOID & its net

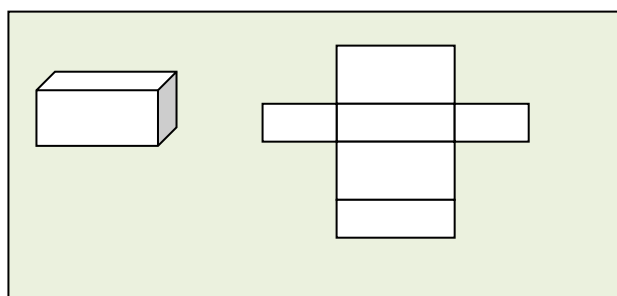

TRIANGULAR PRISM & its net

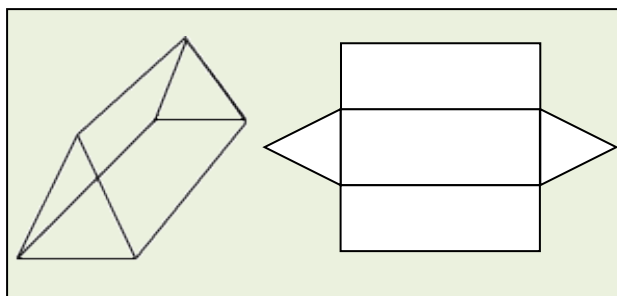

6/23 Construct 2D shapes

6/24 Properties of shapes

TRIANGLES - sum of angles = 180°



ISOSCELES triangle
2 equal sides & 2 equal angles

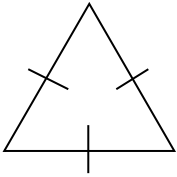

EQUILATERAL triangle
3 equal sides & ALL angles 60°

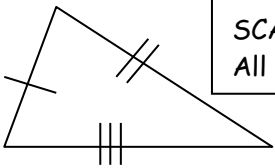

SCALENE triangle
All sides & angles different

$$108^\circ \quad 72^\circ$$

- interior & exterior angle add up to 180°
- the interior angles add up to:
 - Triangle = 1 × 180° = 180°
 - Quadrilateral = 2 × 180° = 360°
 - Pentagon = 3 × 180° = 540°
 - Hexagon = 4 × 180° = 720° etc

QUADRILATERALS - sum of angles = 360°

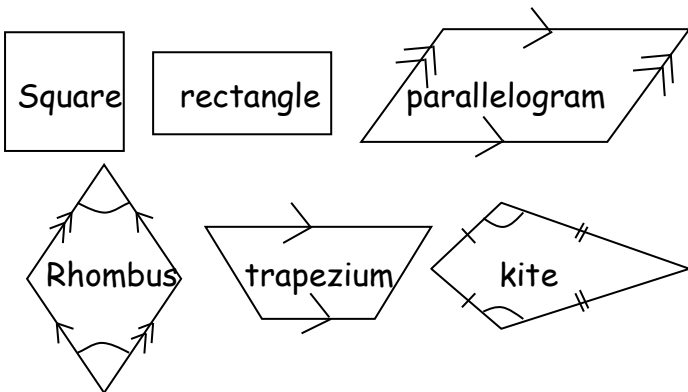

6/25 Parts of a circle

- The circumference is the distance all the way around a circle.
- The diameter is the distance right across the middle of the circle, passing through the centre.
- The radius is the distance halfway across the circle.
- The radius is always half the length of the diameter. ($d = 2 \times r$) or ($r = \frac{1}{2} \times d$)

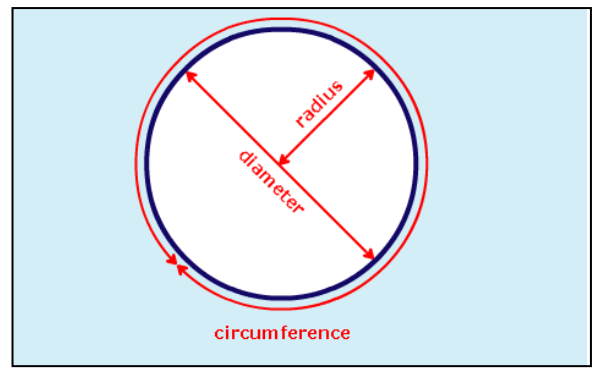

REGULAR POLYGONS - all sides the same

- Polygons have straight sides
- Polygons are named by the number sides
 - 3 sides - triangle
 - 4 sides - quadrilateral
 - 5 sides - pentagon
 - 6 sides - hexagon
 - 7 sides - heptagon
 - 8 sides - octagon
 - 9 sides - nonagon
 - 10 sides - decagon

- Sum of exterior angles is always 360°

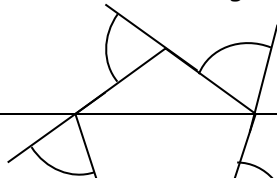

6/26 Angles and straight lines

- Angles on a straight line add up to 180°

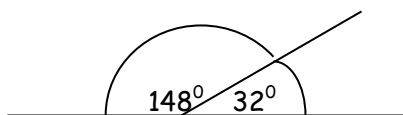

$$148^\circ + 32^\circ = 180^\circ$$

- Angles about a point add up to 360°

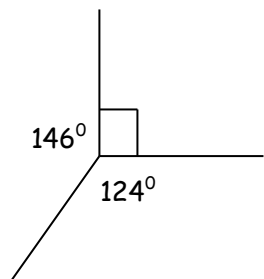

$$146^\circ + 90^\circ + 124^\circ = 360^\circ$$

- Vertically opposite angles are equal

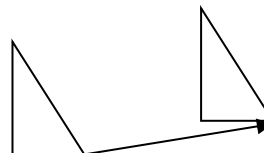
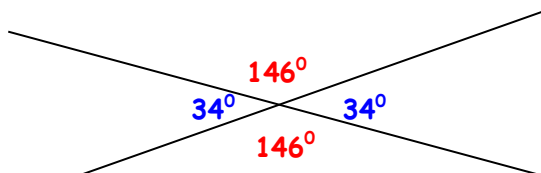

Example - Move shape A 3 right & 4 down

Can also be written as a vector $\begin{pmatrix} 3 \\ -4 \end{pmatrix}$ Right Down

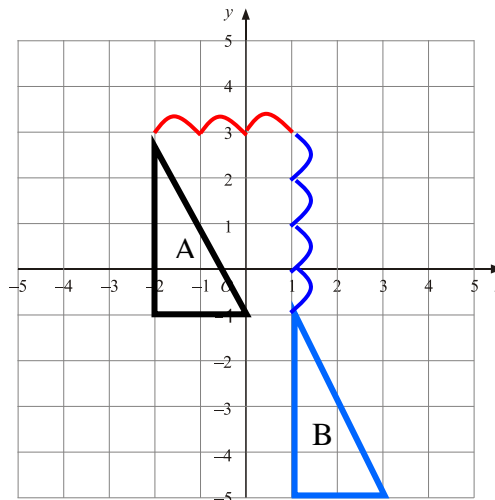

Notice:

- The new shape stays the same way up
- The new shape is the same size

- Reflect a shape in x-axis**

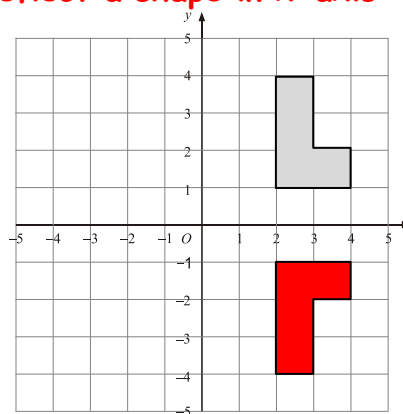

- Reflect a shape in y-axis**

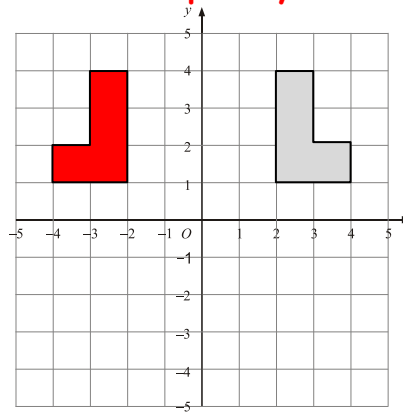

6/27 Position on a co-ordinate grid

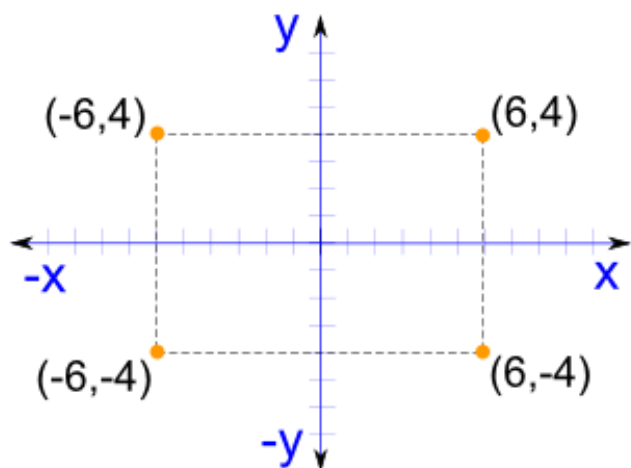

6/28 Transformations

- Translation** - A shape moved along a line

6/29 Graphs

○ **Pie chart**

Transport	Frequency	Angle
Car	13	$13 \times 9 = 117^\circ$
Bus	4	$4 \times 9 = 36^\circ$
Walk	15	$15 \times 9 = 135^\circ$
Cycle	8	$8 \times 9 = 72^\circ$

↑
 Total frequency = 40
 $360^\circ \div 40 = 9^\circ$ per person

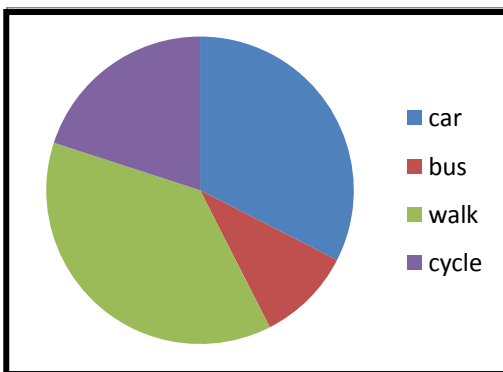

The mean is not a value from the original list. It is a typical value of a set of data

Mean = total of measures ÷ no. of measures

e.g.- Find mean speed of 6 cars travelling on a road

- Car 1 - 66mph
- Car 2 - 57mph
- Car 3 - 71mph
- Car 4 - 54mph
- Car 5 - 69mph
- Car 6 - 58mph

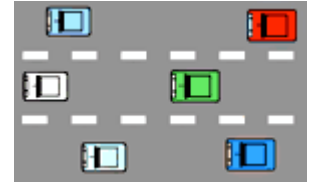

$$\begin{aligned} \text{Mean} &= \frac{66+57+71+54+69+58}{6} \\ &= \frac{375}{6} \\ &= 62.5\text{mph} \\ \text{Mean average speed was } &\underline{62.5\text{mph}} \end{aligned}$$

○ **Line graph**

Line graphs show changes in a single variable - in this graph changes in temperature can be observed.



6/30 The mean

The mean is usually known as the average.



Moorlands Junior School
July 2018